



# WINDOWS, DOORS & CONSERVATORIES

The classic style of a fully sculptured profile



SPECIFICATION GUIDE



## BRITISH STANDARDS INFORMATION

### BS 7412 – PVCu Windows

Kitemark Licence No: KM 33686. Applies to factory glazed frames only.

### BS 7950 – PVCu Windows

Kitemark Licence No: KM 61727. Enhanced Security.

### BS EN 150 9001 – Quality Management System

Certificate No: FM 29754.

**PAS 23**, general performance for doors and **PAS 24**, enhanced security for doors has been achieved by our single residential door, composite door and double doors\*. Certificate No: KM 85377.

Consort PVCu Windows are classified and specified for weather tightness in accordance with BS 6375 Part 1.

\*Subject to specification.



Unit 9b Forrester's Business Park • Estover Close  
Plymouth • Devon • PL6 7PL  
Tel: 01752 696989  
Web: [www.stormsealsw.co.uk](http://www.stormsealsw.co.uk)



© Copyright Consort Ltd. Consort have made every effort to ensure that the information contained in this brochure is correct at the time of publication, but cannot be held responsible for any errors or omissions and reserves the right to change designs, specifications and products at any time without prior notice. Colours are as accurate as printing process allows. Additionally, actual product shade can vary as a consequence of application to various material substrates.







When we set about adding a new beauty to the most respected profile system in the history of PVCu, we didn't take our job lightly.

We knew it had to be much more than just slim and shapely it had to help the fabricator stay lean and mean too, with a whole host of features and innovations to make manufacture an altogether smoother and more efficient business. Need we add that its sleek good looks will make it a winner with housebuilders and homeowners too.

Incorporating all the best features of PVCu, the Consort fs integrated system is a new generation 70mm lead-free profile, combining

the best of style and performance. Proving that beauty can be more than just skin deep, this innovative profile, which has the highest attainable BSI Class 'A' specification, combines strength and value for money with a truly elegant sculptured appearance, following the lines of many timber designs.

Available in a full range of sizes, all with totally integrated system features, the Consort fs range will revolutionise the way you think about windows and doors.



The beauty of Consort fs goes far beyond its striking good looks; it also represents a completely new approach to what the specifier, fabricator, installer, housebuilder and end-user should expect from such an advanced system.

- ◆ Environmentally friendly lead-free 70mm profiles
- ◆ Internally glazed for extra security and ease of unit replacement
- ◆ BS 'Class A' specification profiles (highest attainable)
- ◆ Casement windows – Secured by Design. Police preferred initiative\*
- ◆ Made to BSI specification
- ◆ New superb slimline french doors – fs
- ◆ New fire escape easy clean windows – fs
- ◆ Low sightline gaskets add to the frame's sleek appearance
- ◆ Available in a vast array of coloured foils and woodgrains, as well as all white
- ◆ Any painted colour in the RAL colour range available
- ◆ Achieves a U value of 1.4W/m2k when glazed with 28mm Low E sealed units with Warm Edge spacer bar argon filled cavity\*
- ◆ Energy rated window as standard with glass from Consort

\*Subject to specification.



## CONTENTS

Coloured frames – painted	04 – 05
Coloured frames – foiled	06 – 07
Internally beaded casements	08 – 09
Fire escape windows	10 – 11
Tilt & turn windows	12 – 13
Reversible windows	14
Vertical slider windows	15
Multilock system	16 – 17
Magnum composite doors	18 – 19
70mm composite doors	20
Magnum internal fire doors	21
Single residential doors	22
Stable doors	23
Slimline double doors	24 – 25
Bi-fold doors	26 – 27
WarmCore® folding sliding doors	28 – 29
Tilt & slide patio doors	30
Celsius solid roof conservatories	31
Conservatories	32 – 33
Orangeries	34 – 35
Stratus thermal lantern roofs	36
Fully sculptured profiles	37 – 39

*elegant*  
**Robust**  
*affordable*





Guaranteed resistance to:

- ◆ Weather
- ◆ Alcohol (50%)
- ◆ Spirits
- ◆ Water
- ◆ Scratches
- ◆ Salt



## Fully Sculptured Profile COLOURED FRAMES – PAINTED

A whole new dimension has now been added to the already sleek and truly elegant appearance of the Consort *fs* integrated system... COLOUR!

Not just a single colour, but a vast range, from subtle greys and greens to deep blues, bright reds and even black and metallics. In fact, any colour within the RAL colour range.

At the cutting edge of paint technology, our brand new, environmentally friendly paint shop, staffed with fully trained personnel, is now able to bring you this latest innovation in PVCu.

The complete frame or door is sprayed using a unique coating system, specially formulated to chemically bond with the substrate to form a permanent coating of superior durability and retention of hue and gloss.

With a 10-year adhesion guarantee, this highly durable finish will not crack, flake or peel as it retains sufficient flexibility to move with the material to which it is applied. Thoroughly tested throughout Europe for over 10 years, this advanced colour system has proven resistance to all weather conditions, including salt water.

Virtually fade-free, even on browns and reds, this incredible coating is also UV stable, so you can bring colour back to your home with all the quality, low maintenance, style and benefits of Consort *fs*.





## Fully Sculptured Profile COLOURED FRAMES – FOILED

- ◆ Externally - a slightly textured, coloured foil giving the effect of painted wood
- ◆ Internally - clean white profile
- ◆ Available in a vast array of colours and woodgrains
- ◆ Also available in all white, oak and rosewood effect, which can be specified both internally and externally







## Fully Sculptured Profile INTERNALLY BEADED CASEMENTS

- ◆ Alternative outer frame sizes and transom/mullion available
- ◆ An ideal window for all applications available in a full range of styles and sizes
- ◆ 70mm front to back multi-chambered profiles
- ◆ Available in a vast array of coloured foils and woodgrains as well as all white





Two windows with two handles



Position one: fire escape



Position two: easy clean

## Fully Sculptured Profile FIRE ESCAPE WINDOWS

- ◆ Two windows with two handles
- ◆ Slimline profile
- ◆ 70mm front to back multi-chambered profiles
- ◆ Locking mechanism –  
Master: Multilock locking  
Slave: top and bottom shoot bolts
- ◆ Sliding hinge mechanism for easy cleaning to both windows
- ◆ Available in a vast array of coloured foils and woodgrains as well as all white
- ◆ Full range of sizes available



Position one: fire escape



Position two: easy clean





## Fully Sculptured Profile TILT & TURN WINDOWS

- ◆ An ideal window for many different types of installation from high rise blocks to domestic houses
- ◆ Features include the ability to clean the outside glass from indoors and the ventilation benefits while in the tilt position
- ◆ Face fix or concealed gearing available
- ◆ Alternative sizes of outer frame and transom/mullion available
- ◆ 70mm front to back multi-chambered profiles
- ◆ Available in a vast array of coloured foils and woodgrains as well as all white





## Fully Sculptured Profile VERTICAL SLIDER WINDOWS

- ◆ High Security Three Chambered system (most have two)
- ◆ Ovolo design
- ◆ Rolled in gasket
- ◆ Triple seals
- ◆ 24mm Clearline glazing
- ◆ All the hardware picks up reinforcing
- ◆ Equal sightlines
- ◆ Coupling system
- ◆ Choice of hardware colour
- ◆ Decorative horns – if requested
- ◆ Low maintenance
- ◆ Easy cleaning
- ◆ Specially designed steel enabling window sizes up to 1500 x 2800mm to be manufactured
- ◆ Secured by Design – Police preferred specification\*
- ◆ Available in rosewood, oak, cream and all white in standard lead time. Available in other foils with extended lead time



\* Subject to specification.

## REVERSIBLE WINDOWS

- ◆ Sash rotates 360°
- ◆ Easy cleaning of all surfaces from the inside
- ◆ Two restricted opening positions for ventilation
- ◆ Smooth, easy operation
- ◆ Multipoint locking system
- ◆ Low maintenance
- ◆ Available in rosewood, oak and all white in standard lead time. Available in other foils with extended lead time







## Fully Sculptured Profile MULTILOCK SYSTEM

- ◆ Secured by Design – Police preferred specification
- ◆ Multipoint locking system to satisfy PAS 24 security standard
- ◆ Easy, smooth, simple and secure
- ◆ Robust, durable and corrosion resistant for long life
- ◆ Marine specification for enhanced corrosion protection with 10 year Guarantee
- ◆ Fully tested, heavy gauge materials and fixing points protect against attack
- ◆ Eccentric 7.8mm or 9mm mushroom cams allow weatherseal pressure adjustment
- ◆ Unique design with patent pending

Casement Multilock requires the addition of anti-jemmy to comply with Secured by Design.

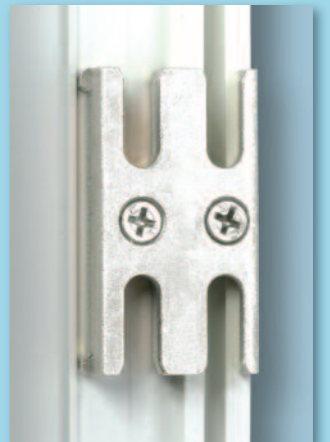





Magnum 14 with Lunna glass



Magnum 4 with Scotia glass



Magnum 49 with Edwardian glass

Magnum 5 with Kara Clear glass

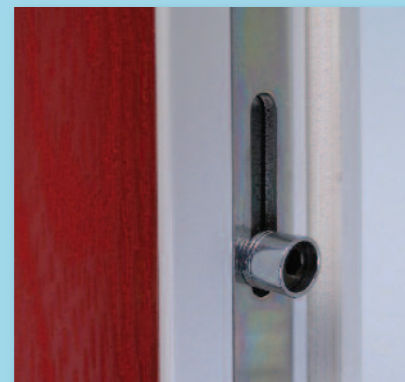

## Fully Sculptured Profile MAGNUM COMPOSITE DOORS

- ◆ Secured by Design – police preferred specification if requested
- ◆ Unique fully adjustable hinges rebated into door for discreet and perfect fit
- ◆ Low threshold – severe weather rated and for easy access
- ◆ Maintenance-free – just wipe clean and never needs painting
- ◆ Solid CFC-free foam core – exceptional strength giving 6 times the insulation and sound proofing of a standard timber or PVCu door
- ◆ Traditional wood appearance – will enhance any new or traditional home
- ◆ Solid door or glazed – plain, obscure, decorative bevelled or coloured glass options available\*
- ◆ Available in a vast array of colours and woodgrains
- ◆ Accessories – stainless steel door handles, knockers and letterboxes available in gold and silver to compliment your door

\* For the complete range of door styles, colours and decorative glass designs, please refer to our Magnum Composite Door brochure.





Magnum 7-70 with Monza glass



Magnum 2-70 with Kara Clear glass



Magnum 3-70 with Aspen glass

## 70mm Double Rebated COMPOSITE DOORS

- ◆ Door Leaf and frame manufactured in the UK to the highest quality under ISO9001
- ◆ Triple glazing as standard – for better heat retention and noise reduction
- ◆ Over 50% thicker than a standard composite door
- ◆ Galvanised steel reinforcement
- ◆ Improved thermal and acoustic insulation thanks to double compression seals
- ◆ Doors come fully framed and glazed, with hardware
- ◆ Available in a vast array of colours



## MAGNUM INTERNAL FIRE DOORS

Fire doors are intrinsic to a building's fire and safety strategy, designed to protect people and property. They can provide an escape route in the event of an emergency and separate zones to help keep fire contained, buying valuable time for building occupants to evacuate.

Constructed with a solid fire retardant core, every door has been fire and smoke tested for up to and beyond 30 minutes and is proven to protect against cold smoke ingress (FD30s).

Monitored throughout its manufacture and fully approved by CERTIFIRE, each door has a fixed identification label detailing its unique reference number to ensure full traceability, providing both installers and homeowners with complete peace of mind.



- ◆ FD30s rated to BS 476 Part 22 and BS 476 Part 31 (smoke)
- ◆ Reinforced PVC frame
- ◆ Low level disability access threshold
- ◆ Certifire approved including hardware in gold or chrome
- ◆ 7mm Pyrodur fire-resistant glass in clear or Stippolyte™
- ◆ Secured by Design – police preferred specification
- ◆ GU Furco Slamlock
- ◆ Lock cases faced with 1mm intumescent pads
- ◆ PAS 023/024 security rated\*
- ◆ CE marked steel butt hinges x 3
- ◆ 15 classic styles available in 11 colours



\* Conditions apply, see separate Magnum Fire Doors leaflet.





## Fully Sculptured Profile SINGLE RESIDENTIAL DOORS

- ◆ Secured by Design – police preferred specification if requested
- ◆ Alternative sizes of outer frame and transom/mullion available
- ◆ Ideal in both domestic and commercial applications, including sheltered housing
- ◆ Available in single or double, sidelights and fanlight combinations
- ◆ 70mm front to back multi-chambered profiles
- ◆ Available inward or outward opening
- ◆ Available internally beaded
- ◆ Available in white, Chartwell green, black, grey, cream, rosewood, oak, Irish oak and foiled white in standard lead time. Available in other foils with extended lead time



## Fully Sculptured Profile STABLE DOORS

- ◆ 'Traditional' Stable Door in PVCu
- ◆ Top and bottom sections both lock
- ◆ Available inward or outward opening
- ◆ Low threshold
- ◆ Multipoint locking system
- ◆ Low maintenance
- ◆ Available in a vast array of coloured foils and woodgrains as well as all white







## Fully Sculptured Profile SLIMLINE DOUBLE DOORS

- ◆ Alternative sizes of outer frame and transom/mullion available
- ◆ Slimline profile
- ◆ 70mm front to back multi-chambered profiles
- ◆ Locking mechanism – Master: two hooks, two rollers, two shoot bolts, latch and deadbolt; Slave: handle operated, two shoot bolts
- ◆ Available inward or outward opening
- ◆ Available internally beaded
- ◆ Available in all white, rosewood and oak in standard lead time. Available in other foils with extended lead time





- ◆ Secured by Design – police preferred specification\*
- ◆ British Standard PAS 24 multi-locking system
- ◆ Highest DSER 'A' energy efficiency rating
- ◆ 16 door style configurations
- ◆ Sash width of up to 1 metre
- ◆ Up to 6 metres wide
- ◆ Three thresholds available – standard, low and ultra-low for interior use
- ◆ Huge range of colours and woodgrains available
- ◆ Fully adjustable hinges
- ◆ Reversible guide wheels



\* Subject to specification.



## Fully Sculptured Profile BI-FOLD DOORS

Blurring the lines between where the home ends and the garden begins, our range of bi-fold doors creates a versatile new living space that fills your home with a unique sense of light and space. In summer cast them wide open to let the fresh air in, and in winter seal them tight and cosy up in the warmth without losing your stunning view.

Bi-fold doors are a stunning alternative to french or patio doors and can be installed so that the doors sit inside or outside of the

property when folded back. Engineered with such precision, they glide smoothly back and forth with only the lightest of touch. Secured when closed by our extremely advanced multi-locking system.

Of course, as well as being a beautiful way to bridge the gap between your home and garden, they can also be used to separate rooms within your home, creating a truly unique and adaptable space.







## WARMCORE® FOLDING SLIDING DOORS

The flexibility of a WarmCore folding sliding door helps your home become a space that works for you. Open and airy on beautiful summer days, warm and insulating in the colder months. Integrating outside living with interiors whilst enhancing both.

Safe and secure, WarmCore aluminium doors are built around a full width orange thermal core to maximise the use of low conductive material. This ensures they are 25% more efficient at keeping heat in your home than traditional aluminium doors, with no compromise on strength or style.

Inwards or outwards opening up to 6 metres wide with as many as 7 opening sashes smoothly gliding along custom designed tracks. The innovative design allows you to split the

door sashes in whichever way suits your home, including having a 'traffic' door at one end for everyday use. When open all sashes stack neatly in line with each other and are kept perfectly parallel using discreet magnets. Open ends of the door sashes, hidden from view when closed, are coloured black for a neat uniform appearance.

WarmCore – warm, stylish, wide span doors for the flexibility of modern living.



- ◆ Full-length 5 point locking system
- ◆ 3 opposed hook locks and twin shoot bolts
- ◆ Integral dog bolts to bind doors together when closed
- ◆ High strength hinges and rollers
- ◆ Secured by Design – police preferred specification when fitted with optional laminate glass upgrade
- ◆ Certified PAS 24 – enhanced security performance
- ◆ 4 external door sash designs
- ◆ 4 threshold options
- ◆ Available in 4 hard-wearing powder coat finishes, Pure White, Heritage Cream, Jet Black and Anthracite Grey

- ◆ Choice of different interior and exterior colour options
- ◆ 3 handle finishes – Matt Black, Brushed Graphite or Satin Silver
- ◆ Easy Clean glass technology available to reduce maintenance
- ◆ Optional triple glazing – 75% better thermal performance





## Fully Sculptured Profile TILT & SLIDE PATIO DOORS

- ◆ Alternative sizes of outer frame available
- ◆ An ideal door for many different types of installation from high rise blocks to domestic houses
- ◆ Available in a full range of styles and sizes including combinations of fixed and opening lights
- ◆ Features include the ventilation benefits while in the tilt position
- ◆ 70mm front to back multi-chambered profiles
- ◆ Available in a vast array of coloured foils and woodgrains as well as all white



## Fully Sculptured Profile CELSIUS SOLID ROOF CONSERVATORIES

We have added the Celsius Solid Roof to our extensive range enabling any homeowner to now have a true 'year round' room. An innovative tiled roof system for new or replacement conservatory style extensions with superior thermal performance, Celsius creates a high quality living space that ensures warmth in winter, yet stays cool in summer.

This unique system has been designed using proven high quality components supplied by the leading companies in their fields. Custom-made to precisely meet requirements and delivered in complete kit form for a quick and easy installation, Celsius offers excellent value for money with reduced labour costs.

Fitting a Celsius Solid Roof will transform the visual impact of any existing traditional-styled glazed roof conservatory, whether Georgian, Victorian, Gable or lean-to. A seamless link between home and garden, ensuring the most is made of outdoor space, whatever the weather.







## Fully Sculptured Profile CONSERVATORIES

Manufactured from modern aluminium and PVCu, our virtually maintenance-free conservatories are individually designed to enhance and extend your home beautifully. No matter if your home is a period property or more contemporary, there is a conservatory to suit every type, seamlessly matching your home in terms of brickwork, colour, shape and style.

The Victorian conservatory is a timeless design, typically having a 3 or 5 panel faceted end, which gives it a unique look and charm. The Georgian or Edwardian conservatory with its flat front and rectangular/square shape, ensures no wasted space and floods the room with light due to its high roof style. Gable style conservatories have two sloped roof sections ending in a vertical gable end. Well suited to older properties making excellent use of the

additional headroom and available internal floor space. Alternatively, the Lean-to or Sun Room is an ideal solution for properties with limited space. Usually rectangular, with clean, uncomplicated lines, and a sloping roof.

Whatever style you choose, you can be assured the conservatory roof has been exhaustively tested to the highest British Standards to be robust, durable and long lasting. You can choose from polycarbonate, which is a damage-resistant, lightweight insulating glazing material, providing resistance against the effects of UV weathering. Or, to give your conservatory that all important wow factor, choose from our range of Low E, self-cleaning or solar controlled glass which dramatically improve views from within your conservatory, and allow for more natural sunlight.







## Fully Sculptured Profile ORANGERIES

Transform your living space and aspire to the grandeur of something completely unique.

Historically, Orangeries were luxury out buildings or extensions used for growing oranges, exotic fruits and trees in winter. Today an Orangery provides a stunningly attractive and seamless extension to your home, that can be used as a kitchen extension, dining room, home office or extra living space for relaxation or entertainment.

The most traditional style of Orangery, and the most expensive, uses traditional materials such as brick or stone pillars between large windows to support the atrium style roof.

As an alternative, using modern design and cutting edge technology, it is now possible to create this unique styling using PVCu and aluminium. The exclusively designed and innovative Consort Load Bearing Corner Posts, make it possible to create a beautiful Orangery with a traditional brick base. With the atrium style roof and concealed lighting adding dramatic impact and a quality feel, an Orangery is the perfect option to bring light, warmth and an immense feeling of space to this and adjoining rooms.

All the benefits of a conservatory plus much, much more.







## FULLY SCULPTURED PROFILES

### Transoms & mullions

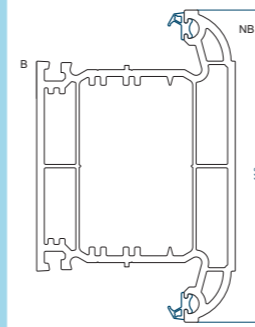

110mm Midrail 102.264  
Box Steel Reinforcement 113.376  
Ported Aluminium Reinforcement 115.286

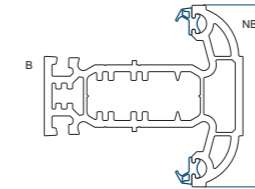

64mm T Mullion 102.261  
Box Steel Reinforcement 113.041  
U Channel Steel Reinforcement 113.321  
Ported Aluminium Reinforcement 115.284

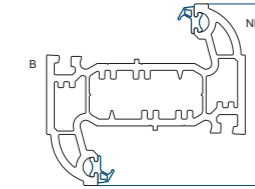

64mm Z Mullion 102.260  
Box Steel Reinforcement 113.041  
U Channel Steel Reinforcement 113.321  
Ported Aluminium Reinforcement 115.284

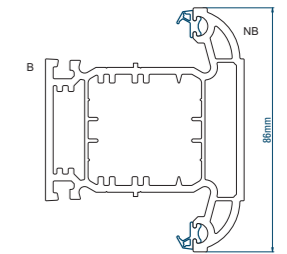

86mm T Mullion 102.263  
Box Steel Reinforcement 113.041  
U Channel Steel Reinforcement 113.321  
C Steel Reinforcement 113.378  
Cranked Steel Reinforcement 113.371  
Ported Aluminium Reinforcement 115.285

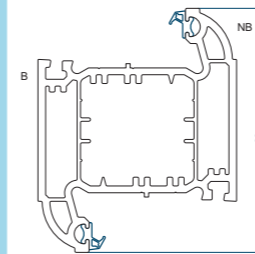

86mm Z Mullion 102.262  
Box Steel Reinforcement 113.041  
U Channel Steel Reinforcement 113.321  
C Steel Reinforcement 113.378  
Cranked Steel Reinforcement 113.371  
Ported Aluminium Reinforcement 115.285

### Window sashes

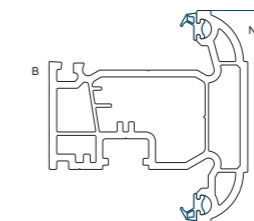

75mm Casement Sash 103.264  
Steel Reinforcement 113.372

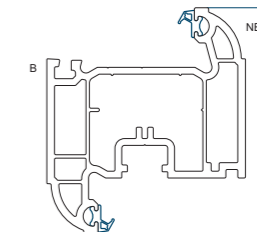

80mm Tilt & Turn Sash 103.267  
Steel Reinforcement 113.373

### Outer frame

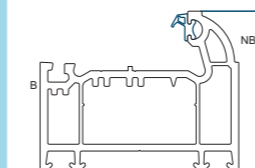

56mm Outer Frame 101.160  
Steel U Channel Reinforcement 113.317

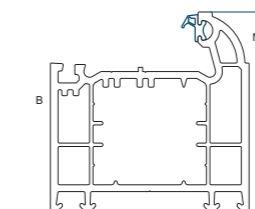

70mm Outer Frame 101.161  
U Channel Steel Reinforcement 113.321  
C Steel Reinforcement 113.378  
Cranked Steel Reinforcement 113.371

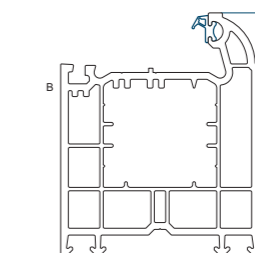

85mm Outer Frame 101.162  
U Channel Steel Reinforcement 113.041  
C Steel Reinforcement 113.378  
Cranked Steel Reinforcement 113.371

### Beads



28mm Glazing Bead  
Co Ex 107.155

### Door sashes

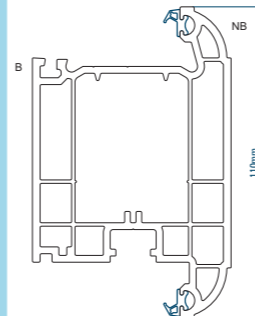

110mm T Residential Door Sash 105.169  
Box Steel Reinforcement 113.231  
U Channel Steel Reinforcement 113.320  
Prepared U Channel Steel Reinforcement 113.318

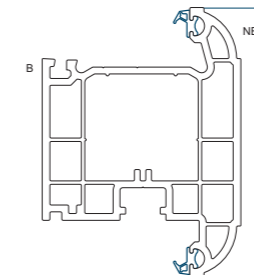

95mm T Double Door Sash 103.266  
U Channel Steel Reinforcement 113.375  
Prepared U Channel Steel Reinforcement 113.374

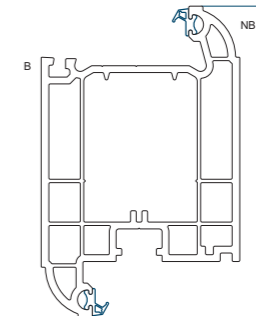

110mm Z Residential Door Sash 105.168  
Box Steel Reinforcement 113.231  
U Channel Steel Reinforcement 113.320  
Prepared U Channel Steel Reinforcement 113.318

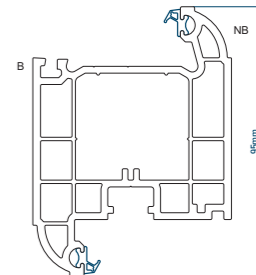

95mm Z Double Door Sash 103.265  
U Channel Steel Reinforcement 113.375  
Prepared U Channel Steel Reinforcement 113.374

## STRATUS THERMAL LANTERN ROOFS

The purpose designed Stratus aluminium lantern roof system is discreet yet stylish, coupling sleek contemporary looks with truly outstanding performance, allowing light to flood into your home's interior.

Designed from the ground up around an innovative thermally broken system, it provides excellent thermal performance, keeping you cool in the summer and warm in the winter, while delivering the architectural refinement you'd expect from a high end aluminium lantern system.

Whether you are building a new kitchen-diner extension or replacing an existing lantern roof, Stratus will help redefine your home, creating light and airy spaces for you to enjoy.

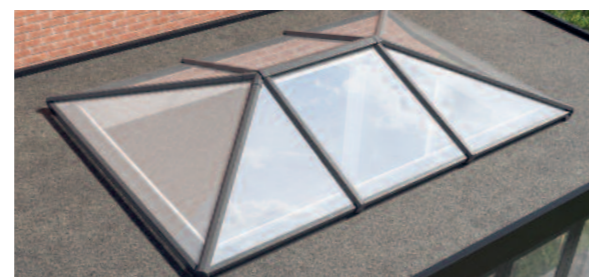
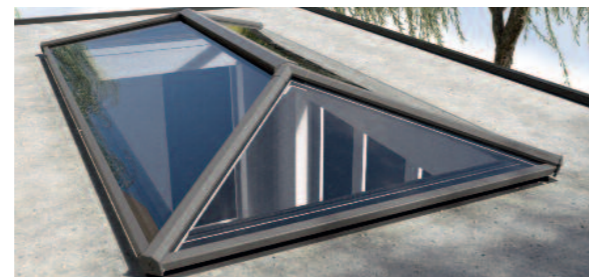



# FULLY SCULPTURED PROFILES – ANCILLARIES

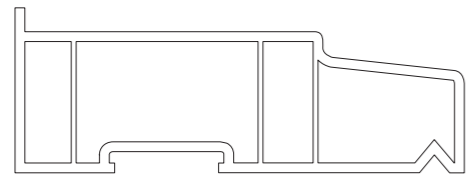

95mm Cill 110.074

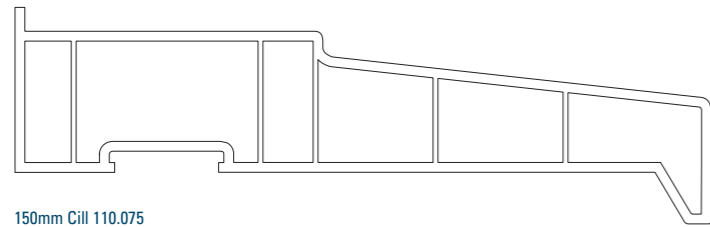

150mm Cill 110.075

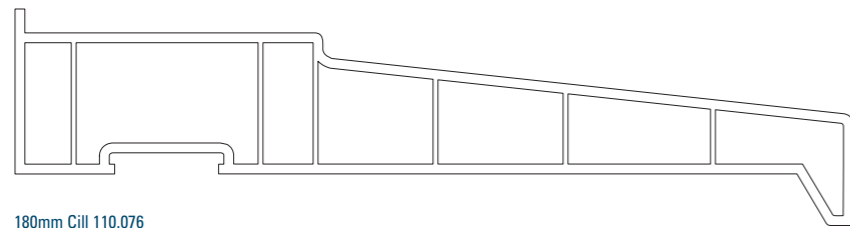

180mm Cill 110.076

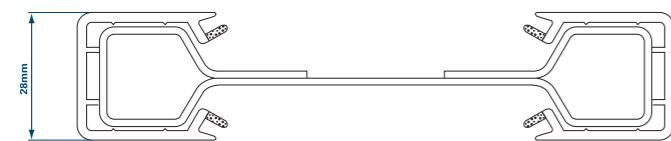

Dog Bone Coupling 113.112  
Cover 116.012



Coupling 116.005

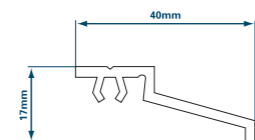

Snap On Head Drip 109.230

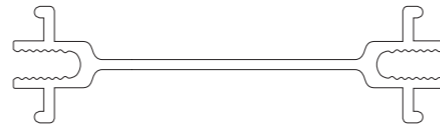

6mm Slide in AL 10

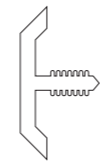

Cover 002 (Qty 2)

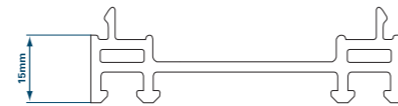

15mm frame extension 114.028

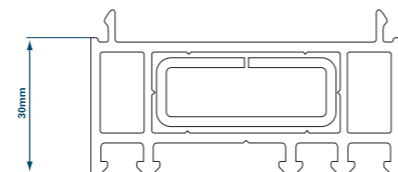

30mm frame extension 114.014  
Reinforcement 113.028

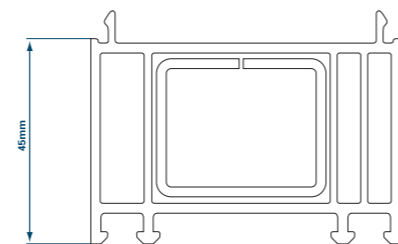

45mm frame extension 114.202  
Reinforcement 113.271

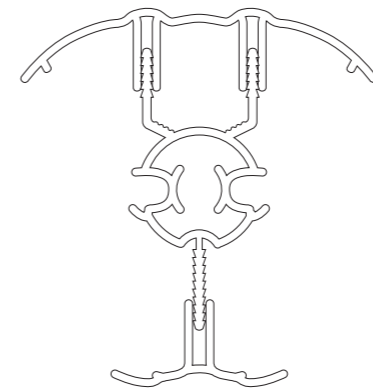

Loadbearing Variable Pole 10145

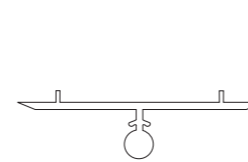

Variable Pole Adapter 10146 (Qty 2)

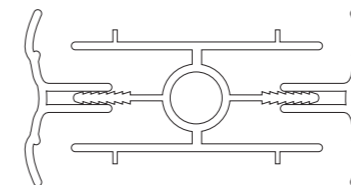

25mm Loadbearing 10148

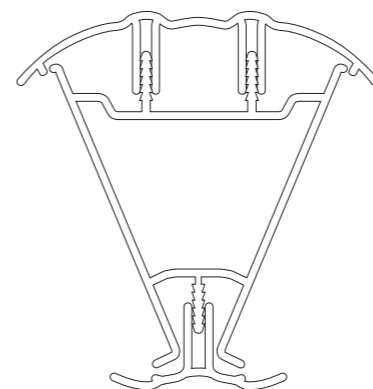

135 Degree Fixed Corner Post 10147  
External Cover 10141  
Internal Cover 10138

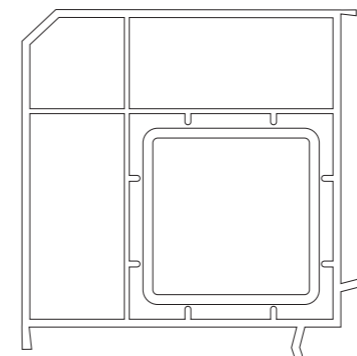

90 Degree Corner Post 116.200  
Aluminium Reinforcement AL 16

